



The P1 has been custom designed and engineered as a cost efficient control solution for small to medium sized rotary, vane and reciprocating air compressors up to 65Bar (950psi).

Interface:

- 6 tactile feedback push button type keys integrated in to the front overlay design.
- Industrial push button Emergency Stop Self locking; twist to unlock.
- 95 element custom backlit LCD



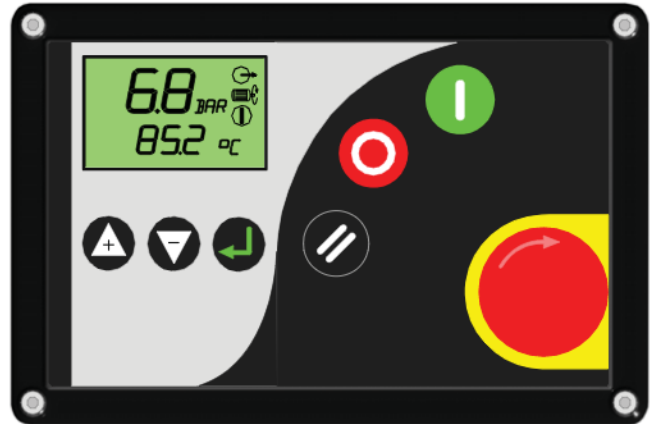

Keys:

	Start		Up or Increment Value
	Stop		Down or Decrement Value
	Reset		Enter

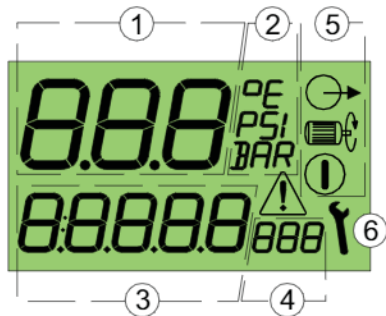

Display:



- | | |
|---------------------------------|---|
| 1: Main Display Value | 0.1 to 999 |
| 2: Main Display Value Units | BAR, PSI, °C, °F |
| 3: User Menu Item Display Value | 0.1 to 99999 |
| 4: User Menu Item Display Units | BAR, PSI, °C, °F, Hr, LHr |
| 5: Status Symbols |  Started,  Running,  Loaded |
| 6: Service/Fault Symbols |  Service,  Fault: Alarm/Warning/Trip |

Construction:

Cast Aluminum alloy housing, process black corrosion protective coating and corrosion protected steel rear plate. IP65 keypad overlay and panel mount sealing.

Mounting:

Front panel mounting (1.0mm to 2.5mm plate thickness) with 4 x M4 clearance holes for front accessible screw, self-tap, nut/bolt or rivet type fixings.

Connections:

0.5mm² to 1.5mm² CSA wire screw terminals.

Emergency Stop – 2 x 110' push fit 'faston' connectors

Earth Tabs – 2 x 250' push fit 'faston' connectors

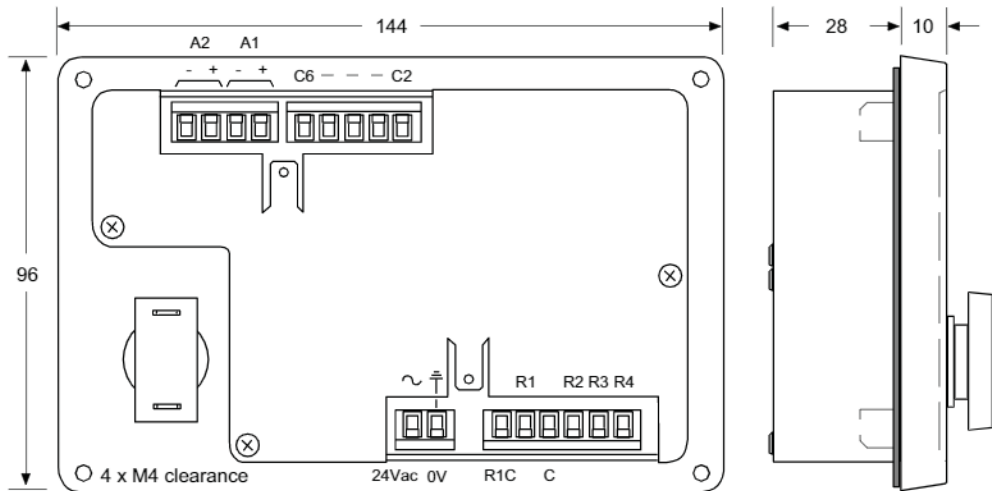

X01 – Power Supply:

Controller: 24Vac +/-15%; 50VA @ 50/60Hz

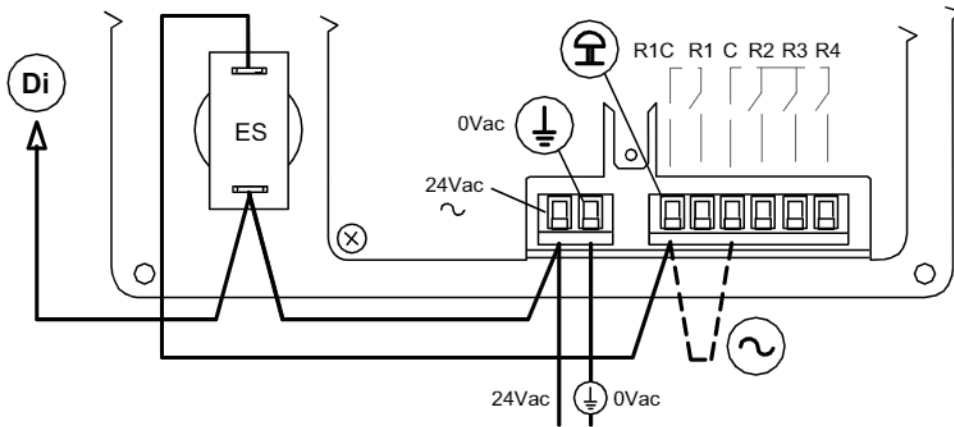

It is recommended the 0Vac power supply is securely bonded to a suitable earth connection. Polarity of power supply connection to the controller is important.



Emergency Stop (ES) activation is detected on R1C (relay #1 common pin); 24Vac only.



If common 24Vac power supply is used for motor contactor coil energisation the 'VA' power supply rating must be increased accordingly.



Main 24Vac power supply is used for digital input activation (digital inputs are 24Vac detecting).

X02 – Analogue Inputs:

Pin Function

1	A1+ Pressure Sensor	+ 16VDC
2	A1- Pressure Sensor	4-20mA Signal
3	A2+ Temperature Sensor	KTY (NTC 10k, PT100, PT1000)
4	A2- Temperature Sensor	0VDC

X03 – Digital Inputs:

Pin Function

Pin	Function	ON: 24Vac	OFF: 0Vac
-	C1 Emergency Stop	<i>see Relay Outputs R1C</i>	
1	C2 Shutdown Trip Fault (e.g. Motor Fault)	OK	Shutdown
2	C3 Shutdown Trip Fault (e.g. Oil Filter)	OK	Shutdown
3	C4 Shutdown Trip Fault (e.g. Separator Element)	OK	Shutdown
4	C5 Menu Configurable (Default: Alarm)	Alarm	OK
5	C6 Menu Configurable (Default: Alarm)	Alarm	OK

! ON= > 19.8Vac, OFF = < 1.0Vac

X04 – Relay Outputs:

Pin Function

1	R1C Emergency Stop Detection; Relay #1 Common	24Vac only (<1.0Vac = E.Stop)
2	R1 Load Solenoid	max. 130Vac/dc
3	C Relay #2, #3 and #4 Common	
4	R2 Main/Line Motor Contactor Coil	
5	R3 Start Motor Contactor Coil	
6	R4 Delta Motor Contactor Coil	

User Display:

7.0_{BAR} 102^{PSI}

Main Display Value; Pressure (bar/psi menu selectable)

85.6^{°C} 186^{°F}

Default User Menu Item; Temperature (°C/°F menu selectable)



To view alternative User Menu items press Up or Down

23456_{HR}

Total Run Hours

16420_{LHR}

Hours Run Onload

420_{HR} ⚡

Hours Until Service Due (countdown timer based on total run hours)

!Add

RS485 Communication Network Address (*only show if RS485 option installed)

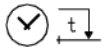

If a timer event occurs (run-on, stop, blowdown or auto restart time) the User item display will show the time countdown in seconds. While a countdown is being displayed normal User items can still be viewed; press Down.

The display will default back to the User Temperature item after a short period of no key activity or after a timer event has completed.

! If operating in 'Pressure Switch Mode' the main display will show the detected temperature and the default User Menu item will be total run hours. Pressure is not displayed in pressure switch mode.



Pressure Switch Mode

Status Display:

The operating status is continuously displayed using status symbols.



Standby: The compressor is in a started state but is not running. The compressor will automatically re-start and load when pressure falls to the lower pressure set point; or a remote load signal.



Running: The compressor is running offload (run-on-time active)



Loaded: The compressor is running onload

Fault Conditions:



If a Fault condition occurs the Fault triangle symbol will switch on steady (Alarm/Warning) or flash (Trip/Shutdown) The User menu display item will show a 'Fault Code' dependant on the fault.



Fault Codes

Service Due Countdown Timer:



If the Service Due countdown timer reaches 0(zero) hours the Service and Alarm symbols will flash and the service Alarm (Warning) code will be displayed. The alarm code can be reset but the service symbol will remain on the display until the service due timer is reset; the service hours will continue to decrement in negative hours. The service countdown timer can be reset, using the menu routine, when the required service has been carried out. Set to any value greater than 0(zero) hours before reset.

The Service Due countdown timer can be reset to any hours value, dependant on the required service interval. The timer will countdown dependant on total run hours.

Menu Routine:

Parameters, Values and Options can be adjusted and set using the Menu Routines. There are two menu lists:

- 1) Operational Menu – Access Code “0009”
- 2) Configuration Menu – Access Code “0121”



To access a menu stop the compressor first then press the Up and Down buttons simultaneously. After several seconds the display will show four “0” characters; the first character will flash. Press Up or Down to adjust the first character to match the first character of the required access code. Press Enter to increment to the second code character.



When all four access code characters have been set, and the last code character is flashing, press Enter. If the access code is correct for access to one of the two menus the first menu item of the appropriate menu will be displayed. If the access code is incorrect the display will return to the normal operational display.

To select a menu item for adjustment press Up or Down until the menu item is displayed. To adjust an item setting press Enter, the value or option will flash. Press Up or Down to adjust as required then press Enter to store in memory.



To exit a menu and return to the normal operational display, at any time, press Reset. Any adjustment that has not been entered to memory will be abandoned and the previous setting maintained.

Operational Menu:

Item	Description	Range	Default
1:	1.Sh Service Interval Hours	-999 to 9999 hours	2000 hours
2:	1.Pu Upper Pressure Set point	1 to 68bar	7.0bar
3:	1.PL Lower Pressure Set point	0.8 to 67.8bar	6.8 bar
4:	1.rt Run-On-Time	0 to 600 seconds	300 seconds (5 minutes)
5:	1.bt Blowdown Time	0 to 120 seconds	30 seconds
6:	1.St Stop Time	0 to 30 seconds	10 seconds
7:	1.P- Pressure Display Units	bar/psi	bar
8:	1.t- Temperature Display Units	°C/°F	°C
9:	1.At Auto Resetart Time	0 to 120 seconds	10 seconds

Operational Menu Items:

Pressure Control:

The compressor will maintain pressure between the set Pu (Unload Pressure Set Point) and PL (Load Pressure Set Point). When Pressure reaches the set ‘Pu’ level the compressor will unload. When pressure falls to the ‘PL’ level the compressor will load.

Run-On-Time:

When the compressor unloads the run-on-timer is initiated. If the set run-on-time expires before the compressor loads again the main motor will stop and the compressor enter the Standby state.

Blowdown Timer:

When the main motor stops the compressor will allow a period of blowdown (the Blowdown Time) before a motor start can be re-initiated. A motor re-start is inhibited during this time period. This time is intended to allow internal pressure (or sump pressure) to be vented before a motor start sequence is permitted. Set to 0(zero) seconds if not required.

Stop Time:

When the Stop button is pressed the compressor will unload and the main motor will continue to run for the set Stop Time. This time is intended to allow internal pressure (or sump pressure) to reduce before the compression element is stopped; preventing potential oil blow-back through the compression element and air filter. The stop time is initiated from the moment the compressor is unloaded. If the compressor has been offload for a period of time prior to a stop command the time is automatically reduced accordingly. If the compressor is stopped after the compressor has been running offload for the stop time, or longer, the compressor is stopped immediately; no stop time is applied. Set to 0(zero) seconds if not required.

Auto Restart Time:

The P1 is equipped with low voltage (<19.8Vac) and power failure detection (>40ms). If a power disturbance or failure occurs while the controller is in a Started state (running or in Standby mode) the compressor will be automatically restarted when power is restored. The controller will display a Power Failure Detected alarm code to indicate this event has occurred. To enable this function select an Auto Restart Time greater than 0(zero) seconds. When power is restored the controller will wait for the set Auto Restart Time before initiating a motor start sequence. This time is intended as a warning period and/or a method of stagger starting a number of compressors on the same power supply distribution system. To disable (inhibit) the Auto Restart function set the time to 0(zero) seconds.

Configuration Menu:

Item	Description	Range	Default
1:	2.Sd Motor Star/Delta Time	0.0 to 20.0 seconds	5.0 seconds
2:	2.Ad Network Address (RS485 option)	1 to 12	1
3:	2.LS Load Source	0=local, 1=RS485, 2=Dig.In.	0=local
4:	2.SS Start Source	0=local, 1=RS485, 2=Dig.In.	0=local
5:	2.PA High Pressure Alarm Level	1.0 to 68.0bar	7.6bar
6:	2.PF High Pressure Trip Fault Level	0.8 to 67.8bar	8.0bar
7:	2.tA High Temperature Alarm Level	50 to 248 °C	110 °C
8:	2.tF High Temperature Trip Fault Level	52 to 250 °C	120 °C
9:	2.d2 Digital Input 'C2' configuration	2: Eno - Shutdown Trip @ 24Vac (0Vac=OK) 3: Enc - Shutdown Trip @ 0Vac (24Vac=OK) - <i>default</i>	
10:	2.d3 Digital Input 'C3' configuration	2: Eno - Shutdown Trip @ 24Vac (0Vac=OK) 3: Enc - Shutdown Trip @ 0Vac (24Vac=OK) - <i>default</i>	
11:	2.d4 Digital Input 'C4' configuration	2: Eno - Shutdown Trip @ 24Vac (0Vac=OK) 3: Enc - Shutdown Trip @ 0Vac (24Vac=OK) - <i>default</i>	
12:	2.d5 Digital Input 'C5' configuration	0: Ano - Alarm @ 24Vac (0Vac=OK) - <i>default</i> 1: Anc - Alarm @ 0Vac (24Vac=OK) 2: Eno - Shutdown Trip @ 24Vac (0Vac=OK) 3: Enc - Shutdown Trip @ 0Vac (24Vac=OK) 4: rSS - Remote Start/Stop (0 to 24Vac transition=Start)	
13:	2.d6 Digital input 'C6' configuration	0: Ano - Alarm @ 24Vac (0Vac=OK) - <i>default</i> 1: Anc - Alarm @ 0Vac (24Vac=OK) 2: Eno - Shutdown Trip @ 24Vac (0Vac=OK) 3: Enc - Shutdown Trip @ 0Vac (24Vac=OK) 4: rLu - Remote Load/Unload (24Vac=Load) 5: PSr - Pressure Switch Regulation (24Vac=Load)	
14:	2.Po Pressure sensor 'offset' calibration	-1.5 to 1.5bar	0.0bar
15:	2.Pr Pressure sensor 'range' calibration	0.0 to 105bar	16.0bar
16:	2.tL Low Temperature Load Inhibit	1 to 70°C (0 = disable function)	2.0°C
17:	2.tr Low Temperature Run Inhibit	-20 to 10°C	-10.0°C

Configuration Menu Items:

2.Sd - Motor Star/Delta Time:

The number of seconds the main motor will run in Star configuration, during a motor start sequence, before transition to Delta configuration.

- The Star motor contractor is energised 200ms before the Main motor contactor.
- The Star to Delta contactor transition time is fixed at 50ms.

2.Ad - Network Address:

The RS485 network communication address and the compressor number. Each compressor, connected to the same network, must be assigned a unique address starting from 1 to the number of compressors on the network system.



RS485 Communications Option

2.LS - Load Source:

- 1) LS = 0 : Compressor will operate using the local set 'Pu' and 'PL' pressure set points.
- 2) LS = 1 : The compressor will respond to remote RS485 system management pressure control.
- 3) LS = 2 : The compressor will load and unload in response to a digital input signal. → 2.d6: will automatically change to 'rLU' (not editable).

⚠ Local pressure control (Pu and PL) is automatically resumed if RS485 communications is disrupted or lost. When RS485 communications are resumed, pressure control is automatically reverted back to RS485 control.

2.SS - Start Source:

- 1) SS = 0 : The compressor can be started using the local Start button.
- 2) SS = 1 : The compressor can be started using remote RS485 communications; the local start button is inhibited.
- 3) SS = 2 : The compressor can be started using a digital input. → 2.d5: will automatically change to 'rSS' (not editable).

⚠ Local and remote Stop functions are always active.

2.d5:rSS – Remote Start/Stop:

The controller can be set to start and stop in response to a 24Vac signal (derived from the main 24Vac power supply). When this option is selected the local start button is ignored. The compressor will start when 0 to 24Vac transition is detected on digital input C5, and stop when the voltage is removed from C5. The local stop button remains active.

To enable this digital input function for d5, you change '2.SS' to 2.

2.d6:rLu - Remote Load/Unload:

The controller can be set to load and unload in response to a 24Vac signal (derived from the main 24Vac power supply). When this option is selected the local pressure set points 'Pu' and 'PL' are ignored. The compressor will load when 24Vac is detected on digital input C6, and unload when the voltage is removed from C6. This feature is intended for remote pressure switch control or remote sequence management control.

To enable this digital input function for d6, you change '2.LS' to 2.

⚠ Local pressure continues to be displayed; high pressure Alarm (Warning) and shutdown Trip settings remain active.

2.d6:PSr - Pressure Switch Mode:

In Pressure Switch Mode the controller will load and unload in response to a 24Vac signal (derived from the main 24Vac power supply). When this option is selected the local pressure set points 'Pu' and 'PL' are ignored. The compressor will load when 24Vac is detected on digital input C6, and unload when the voltage is removed. This feature is intended for operation from a local pressure switch device (PS).

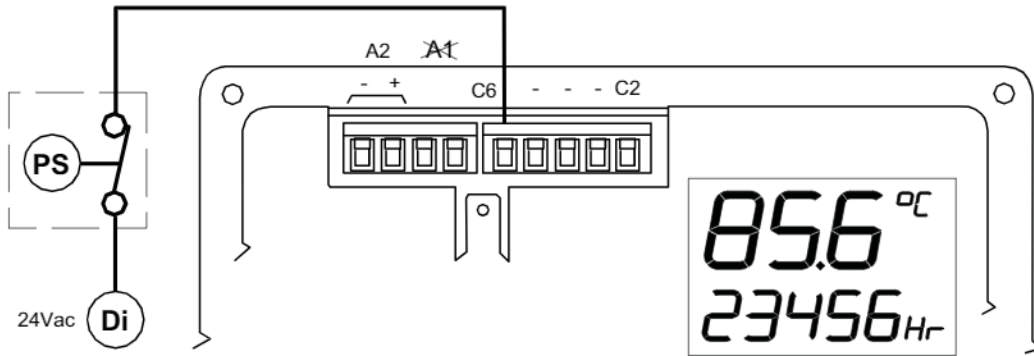

The local detected pressure input 'A1' is ignored and pressure is not displayed. The main display value will show the detected Temperature. There is no requirement to connect a 4-20mA pressure sensor to analogue input 'A1' in this mode.

⚠ A temperature sensor is compulsory in all modes.

⚠ The high pressure Alarm (Warning) and shutdown Trip settings are ignored. It is recommended alternative excess pressure shutdown, utilising a shutdown digital input, is implemented.

Pressure Switch Mode is intended for compressor units that are equipped with a pressure switch but are not equipped with a pressure sensor.

2.Po/2.Pr - Pressure Sensor Type:

The controller is designed for use with a 4-20mA type pressure sensor that can operate from a 16VDC supply. The 'range' of the sensor, and sensor calibration, can be adjusted using the 'Po' (pressure sensor offset) and 'Pr' (pressure sensor range) values. As default these values are set for a 0-16.0bar (0-232psi) sensor.

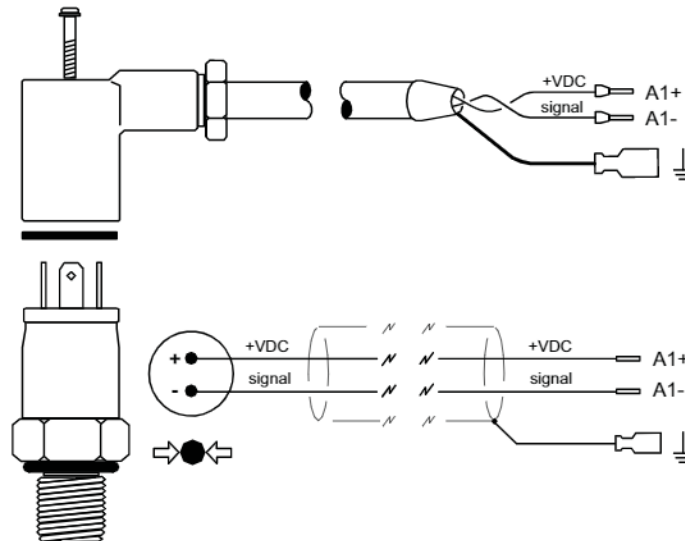

⚠ Wire polarity is important

If a sensor with a different range is used, initially set the 'Pr' range value to match the sensor; then calibrate. For example: for a 0-60bar sensor set the 'Pr' range value to 60.0bar.

If the sensor has a non-zero lower pressure limit, -1.0 (minus one) to 15bar for example, initially set the 'Po' offset to -1.0 (minus one) bar and the 'Pr' range to 15.0bar; then calibrate.

Pressure Sensor Calibration:

- 1) Expose the sensor to atmosphere (0.0bar gauge). Adjust the 'Po' offset value until the displayed pressure is 0.0bar.
- 2) Apply a known accurate pressure to the sensor. The pressure can be static or dynamic (changing). Adjust the 'Pr' range value until the displayed pressure matches the applied pressure. The applied pressure can be any value but It is recommended the pressure be equivalent to, or greater than, normal working pressure to ensure an accurate calibration.

ⓘ Detected pressure is displayed when the 'Po' and Pr' menu items are selected for adjustment.

ⓘ The controller will automatically adjust the pressure fault levels, and the pressure set points, to ensure they remain within the pressure sensor range. Always check and confirm these values after a pressure sensor 'offset' or 'range' adjustment.

2.tL - Low Temperature Load Inhibit

If detected temperature is below the set low temperature limit, and a load condition is required, the controller will inhibit the compressor from loading, and the compressor will run offload, until temperature increases above the set limit. When this condition occurs the controller will display an Alarm indication (A3423 Err). The Alarm will self reset when temperature increases above the set limit. The alarm cannot be manually reset.

To disable this function set to 0(zero).

2.tr - Low Temperature Run Inhibit

If detected temperature is below the set low temperature limit, and a load condition is required, the controller will inhibit a main motor start, and the compressor will remain in a standby condition, until temperature increases above the set limit. If a load condition is still required when temperature increases above the set limit the compressor will automatically start and run. When this condition occurs the controller will display an Alarm indication (A3123 Err). The Alarm will self reset when temperature increases above the set limit. The alarm cannot be manually reset. This feature cannot be disabled.

This function will not stop or inhibit a compressor from operating if the main motor is already running; the function only applies when the main motor is stopped and the controller is required to initiate a motor start sequence.

🔧 Service Function:

To force the compressor in to an offload condition, regardless of pressure level, press and hold RESET for 5 seconds.

- The lower display will indicate 'OFF' (press DOWN to view the temperature or other user menu items)
- ☀ The load status symbol will flash (without the delivery arrow)
- The motor run-on-timer is inhibited; the compressor will continue to run indefinitely in an offload condition.

ⓧ To exit the service function, and resume normal operation, press RESET.

The service function will self cancel if the compressor is stopped; normal operation will resume when the compressor is restarted.

Temperature Sensor:

The P1 is designed as standard to use a KTY type temperature sensor. A KTY sensor offers a calibration temperature range of -32°C to 150°C .

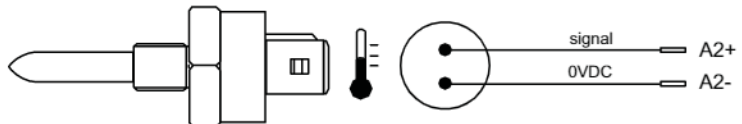

Special builds (on request) can accommodate 10k NTC, PT100 or PT1000 type sensors in instances where a different or higher temperature range (-50°C to 250°C) is required; reciprocating compressor application for example.

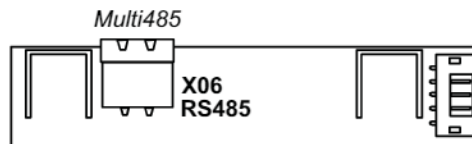

RS485 Communications Option:

The P1 can be factory fitted, or retro-fitted, with an optional 2-wire RS485 serial communications port. The RS485 option is automatically detected, no menu adjustments are required.

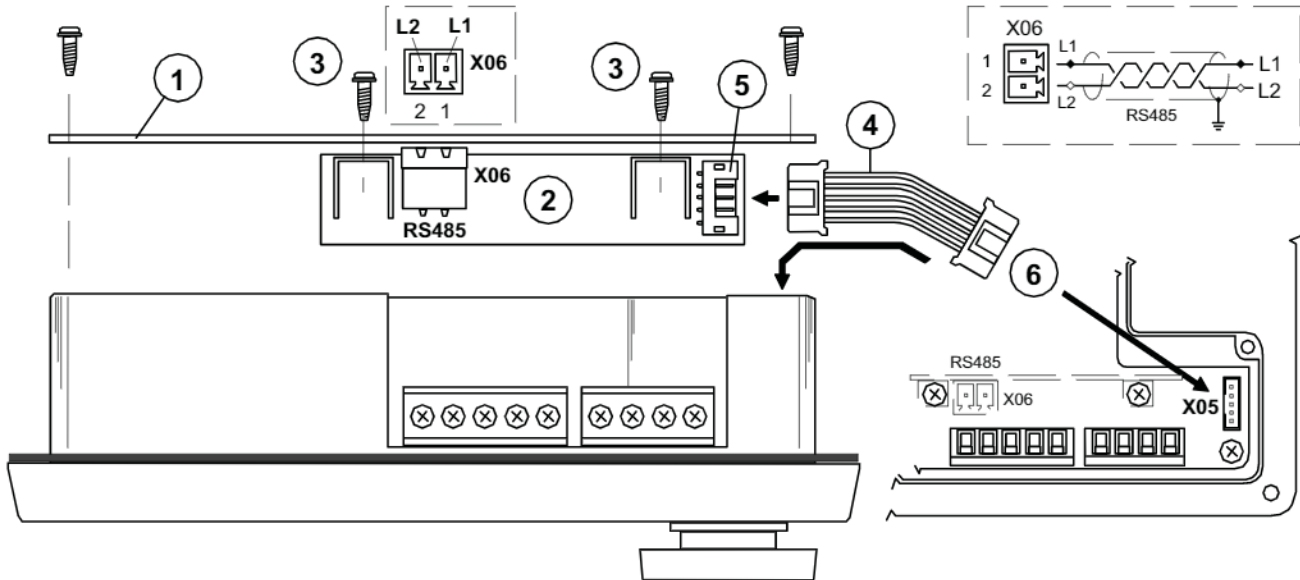

a: Remove the P1 rear cover plate (1).

b: Attach the RS485 PCB (2) to the underside of the P1 rear cover plate using the two screw fixings provided (3); the P1 rear cover plate is equipped with two mounting holes for this purpose.

c: Connect the RS485 PCB cable (4) to the RS485 PCB socket (5)

d: Connect the second end of the RS485 PCB cable (4) to plug X05 on the P1 PCB (6).

⚠ Ensure the RS485 PCB cable plugs are tight and secure.

e: Replace the P1 rear cover plate (1)

⚠ Handle with care - ensure the RS485 PCB cable plugs are not pulled from the sockets during this procedure.

Multi485 Protocol:

The port utilises the CMC Multi485 protocol enabling connectivity to a range of system management products, remote communications monitoring and control options or MODBUS RTU connectivity using a MODBUS Gateway module.

Fault Codes:

Fault conditions are separated in to two categories:



A: Alarm (Warning) – symbol illuminated on steady, the compressor will continue to operate

A:2050	C5 (if set for alarm warning function)
A:2060	C6 (if set for alarm warning function)
A:2118	High Pressure: alarm limit exceeded
A:2128	High Temperature: alarm limit exceeded
A:2816	Power Failure Detected
A:3123	Run Inhibited - temperature is below set low temperature run inhibit limit <i>(will self reset when temperature increases above the set temperature limit; cannot be manually reset)</i>
A:3423	Load Inhibited - temperature is below set low temperature load inhibit limit <i>(will self reset when temperature increases above the set temperature limit; cannot be manually reset)</i>
A:4804	Service Due – service interval hours counter has reduced to zero



E: Shutdown (Trip) – symbol will flash, the compressor will stop.

E:0010	Emergency Stop – 24Vac in not being detected on terminal R1C
E:0020	C2 – fault condition detected on digital input C2
E:0030	C3 – fault condition detected on digital input C3
E:0040	C4 – fault condition detected on digital input C4
E:0050	C5 (if set for shutdown trip function)
E:0060	C6 (if set for shutdown trip function)
E:0115	Pressure Sensor Fault: 4-20mA signal out-of-range (< 3.8mA or > 20.8mA)
E:0119	Excess Pressure: shutdown limit exceeded
E:0125	Temperature Sensor Fault: signal out-of-range (< -50°C or > 250°C)
E:0129	Excess Temperature: shutdown limit exceeded



Master Reset:

The controller can be reset to factory default.

ⓘ This function will reset all menu parameters and options.

- 1) Press the Up and Down buttons simulaniously to display the access code entry screen
- 2) Enter an access code of '9750'
- 3) DO NOT press Enter when the last numeric character "0" is flashing
- 4) While the "9750" access code is still being displayed on the screen, press and hold the Stop button
- 5) After 10 seconds the controller will reset; all values, parameters and options will reset to factory default.

Mounting Options:

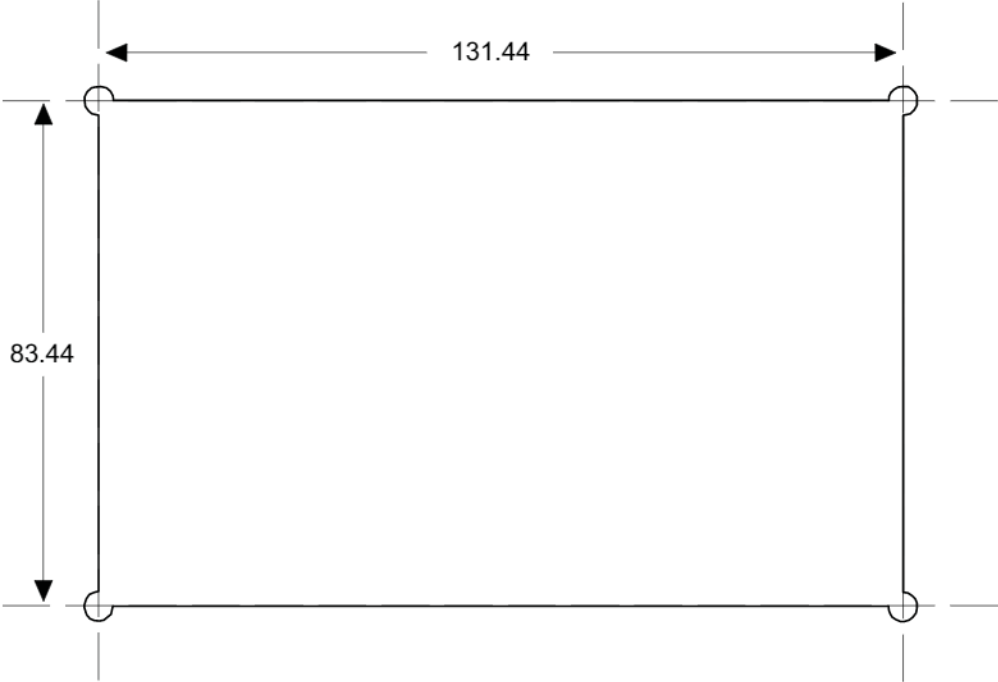
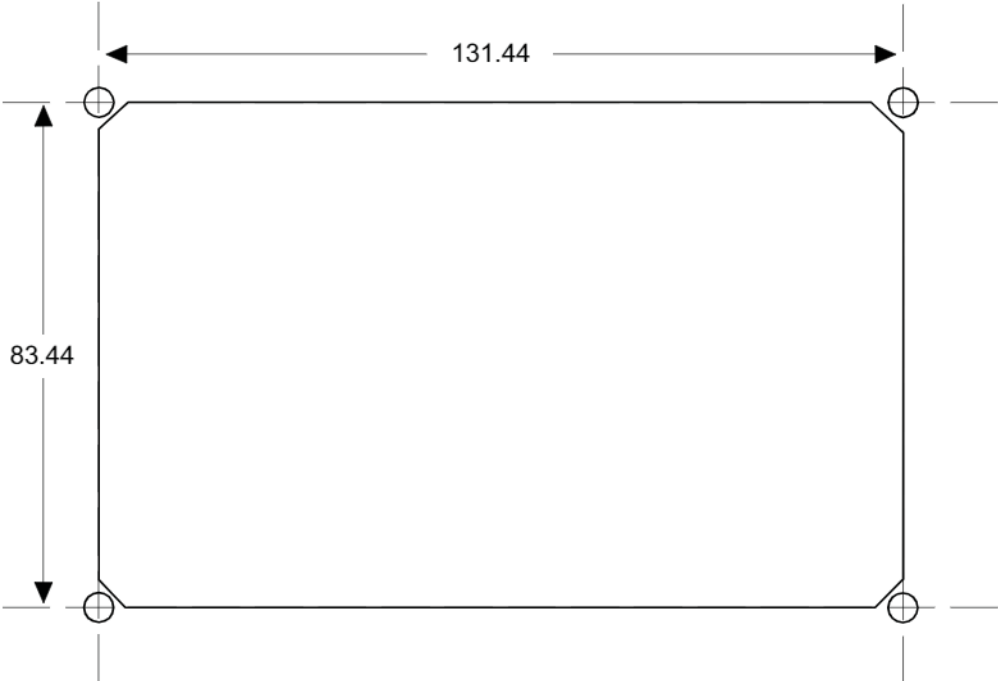

⚠ not to scale